

REV.	ECN NO.	MODIFIED MARK	APPROVED
A	—	FIRST RELEASE	

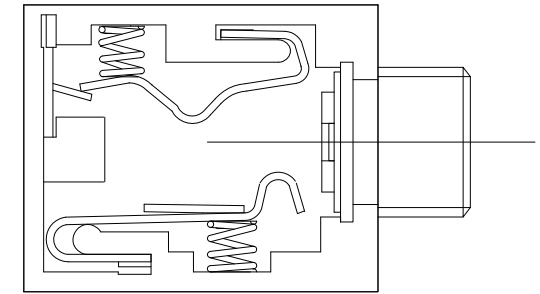

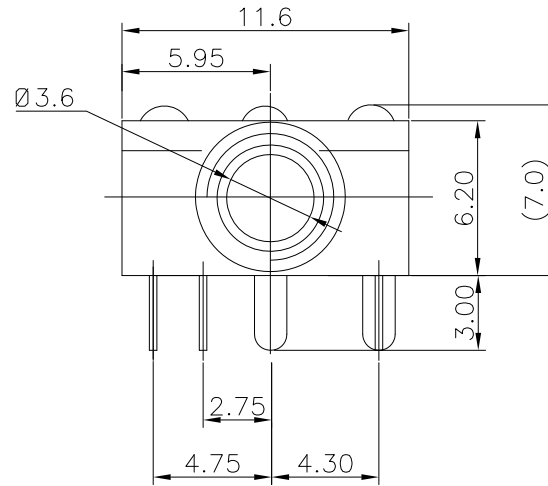

INTERNAL CONSTRUCTION

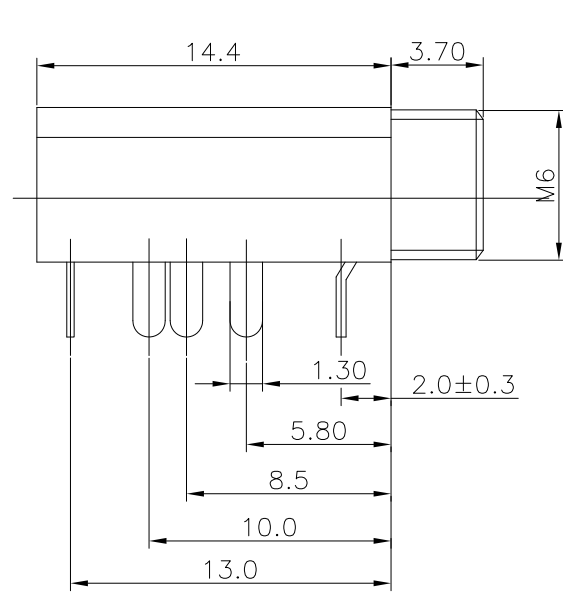
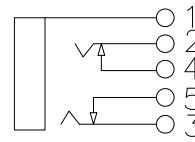
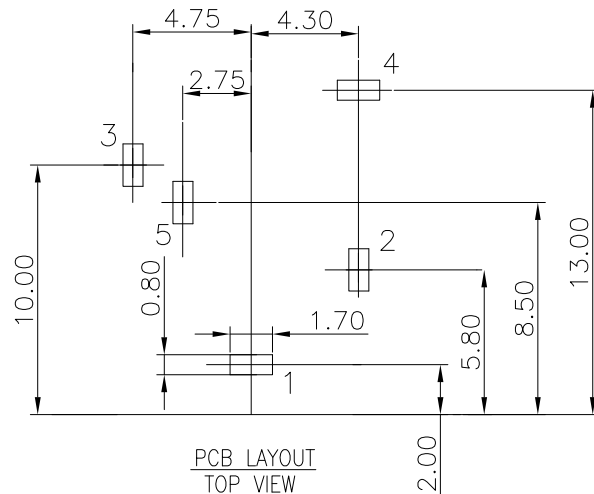

SCHEMATIC

- NOTES:
- ELECTRICAL:
- 1: RATED CURRENT: 1A Max.
 - 2: RATED VOLTAGE: 30V AC.
 - 3: CONTACT RESISTANCE: 100 MILLIOHMS Max.
AFTER TESTING: 100 MILLIOHMS Max.
 - 4: INSULATION RESISTANCE: 100 MEGAOHMS Min.
 - 5: DIELECTRIC WITHSTANDING VOLTAGE: 500 VAC Min.
- MECHANICAL:
- 1: INSERTION FORCE: 3N-25N.
 - 2: WITHDRAWAL FORCE: 3N-25N.
 - 3: DURRABILITY: 5000 CYCLES.
- ENVIRONMENTAL:
- TEMPERATURE RANGE: -20°C TO 60°C.

ANGLE	±5°	MODEL NAME: SJ3507 (PART NO.)	 广东正宝科技有限公司 GUANGDONG TRENPRO TECHNOLOGY CO. LTD.					
63 < L	±0.5							
16 < L ≤ 63	±0.4							
4 < L ≤ 16	±0.3							
L ≤ 4	±0.2							
TOL TABLE:		MAT'L: See table	DESIGN: X.H.Wang 11/05'18	TITLE: 3.5 PHONE JACK				
THIS DOCUMENT IS THE PROPERTY OF TRENPRO TECHNOLOGY CO. LTD. NO PART THEREOF MAY BE REPRODUCED AND USED WITHOUT THE PRIOR WRITTEN CONSENT OF THE OWNER		FINISH: See table	CHECKED: L.W.Wu 11/05'18	DWG NO.:		REV.: A		
		Q'TY: /	APPROVED: X.Q.Hu 11/05'18	UNIT: mm	VIEW: 	SCALE: 5:1	SHEET: 1/1	SIZE: A3