

REV.	ECN NO.	MODIFIED MARK	APPROVED
A	—	FIRST RELEASE	

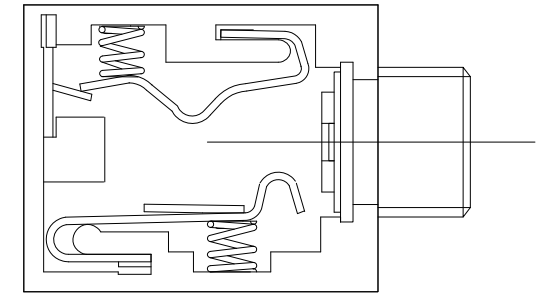

INTERNAL CONSTRUCTION

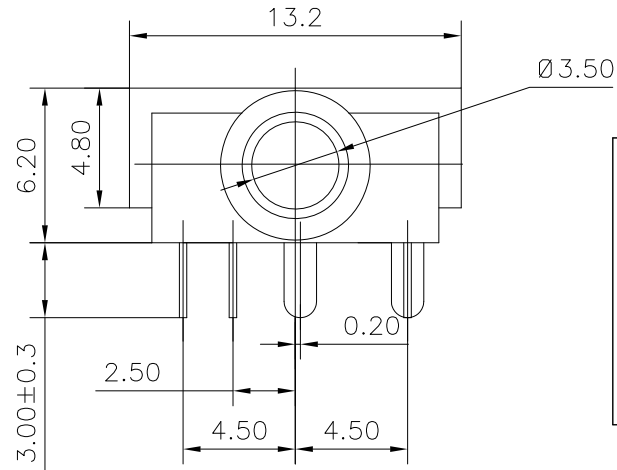
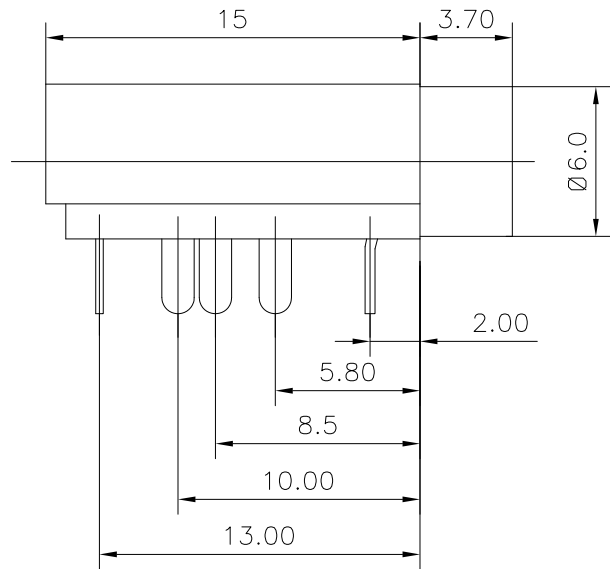
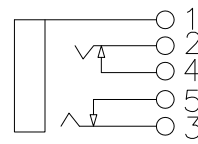
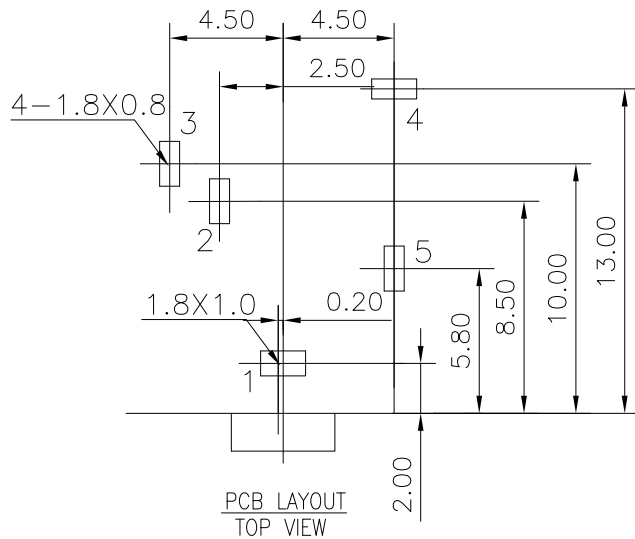

SCHEMATIC

NOTES:

ELECTRICAL:



- 1: RATED CURRENT: 1A Max.
- 2: RATED VOLTAGE: 30V AC.
- 3: CONTACT RESISTANCE: 100 MILLIOHMS Max.  
AFTER TESTING: 100 MILLIOHMS Max.
- 4: INSULATION RESISTANCE: 100 MEGAOHMS Min.
- 5: DIELECTRIC WITHSTANDING VOLTAGE: 500 VAC Min.

MECHANICAL:

- 1: INSERTION FORCE: 3N-25N.
- 2: WITHDRAWAL FORCE: 3N-25N.
- 3: DURABILITY: 5000 CYCLES.

ENVIRONMENTAL:

TEMPERATURE RANGE: -20°C TO 60°C.

ANGLE	±5°	MODEL NAME: SJ3508-FB (PART NO.)		 广东正宝科技有限公司 GUANGDONG TRENPRO TECHNOLOGY CO. LTD.				
63 < L	±0.5	MAT'L: See table	DESIGN: X.H.Wang 11/05'18	TITLE: 3.5 PHONE JACK				
16 < L ≤ 63	±0.4			DWG NO.:				
4 < L ≤ 16	±0.3	FINISH: See table	CHECKED: L.W.Wu 11/05'18	REV.: A				
L ≤ 4	±0.2			DWG NO.:				
TOL TABLE:		Q'TY: /	APPROVED: X.Q.Hu 11/05'18	UNIT: mm	VIEW: 	SCALE: 5:1	SHEET: 1/1	SIZE: A3
THIS DOCUMENT IS THE PROPERTY OF TRENPRO TECHNOLOGY CO. LTD. NO PART THEREOF MAY BE REPRODUCED AND USED WITHOUT THE PRIOR WRITTEN CONSENT OF THE OWNER								