

REV.	ECN NO.	MODIFIED MARK	APPROVED
A	—	FIRST RELEASE	

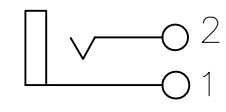

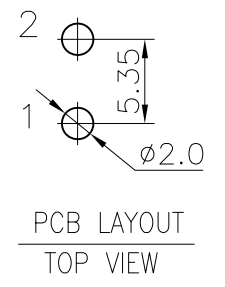

SCHMATIC

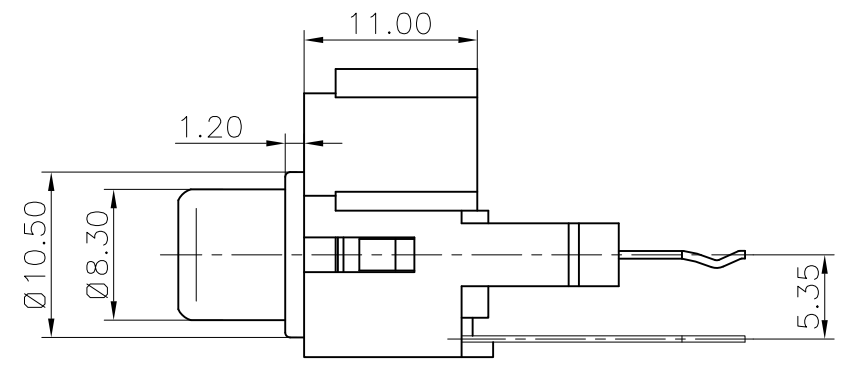
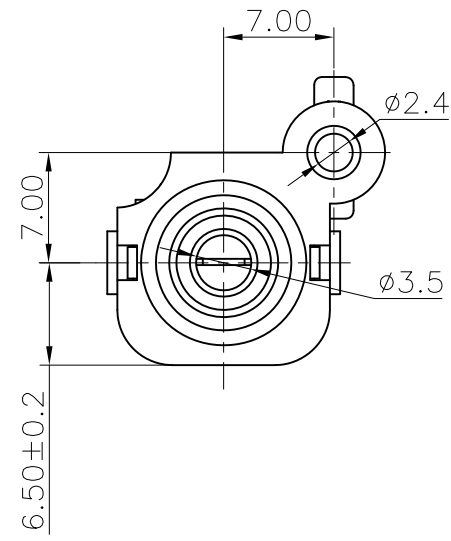
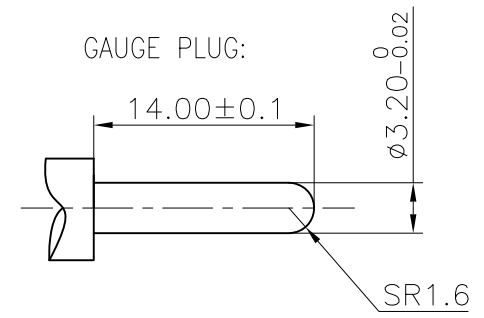
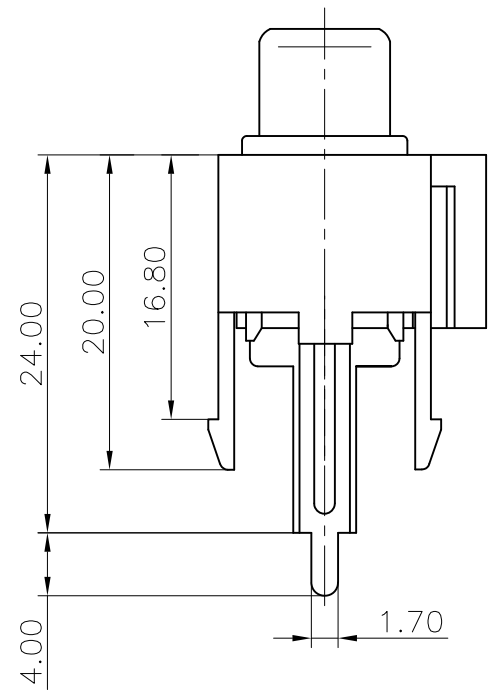

NOTES:
ELECTRICAL:
1:RATED CURRENT: 0.2A Max.
2:RATED VOLTAGE: 50V AC.
3:CONTACT RESISTANCE: 30 MILLIOHMS Max.
AFTER TESTING:100 MILLIOHMS Max.
4:INSULATION RESISTANCE: 100 MEGAOHMS Min.
5:DIELECTRIC WITHSTANDING VOLTAGE: 500 VAC Min.
MECHANICAL:
1:INSERTION FORCE: 3N-30N.
2:WITHDRAWAL FORCE: 3N-30N.
3:DURRABILITY: 100 CYCLES.
ENVIRONMENTAL:
TEMPERATURE RANGE: -20°C TO 60°C.

ANGLE	±5°
63 < L	±0.5
16 < L ≤ 63	±0.4
4 < L ≤ 16	±0.3
L ≤ 4	±0.2
TOL TABLE:	
THIS DOCUMENT IS THE PROPERTY OF TRENPRO TECHNOLOGY CO. LTD.,NO PART THEREOF MAY BE REPRODUCED AND USED WITHOUT THE PRIOR WRITTEN CONSENT OF THE OWNER	

MODEL NAME: RCA-128A (PART NO.)	
MAT'L: See table	DESIGN: X.H.Wang 10/17'18
FINISH: See table	CHECKED: L.W.Wu 10/17'18
Q'TY: /	APPROVED: X.Q.Hu 10/17'18

 广东正宝科技有限公司 GUANGDONG TRENPRO TECHNOLOGY CO. LTD.	
TITLE: RCA PIN JACK	
DWG NO.:	
UNIT: mm	VIEW: 
SCALE: 5:1	SHEET: 1/1
SIZE: A3	REV.: A