

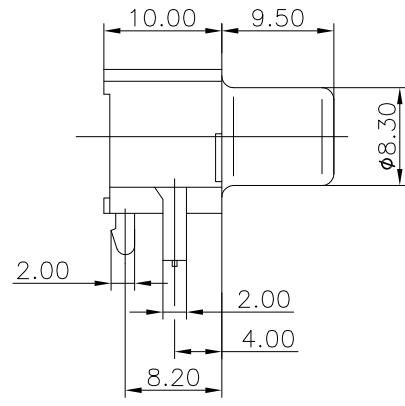

REV.	ECN NO.	MODIFIED MARK	APPROVED
A	—	FIRST RELEASE	

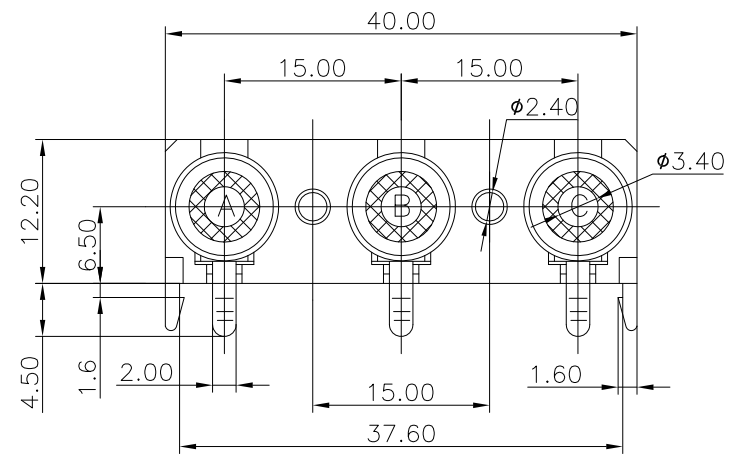

NOTES:  
 ELECTRICAL:  
 1:RATED CURRENT: 0.2A Max.  
 2:RATED VOLTAGE: 50V AC.  
 3:CONTACT RESISTANCE: 30 MILLIOHMS Max.  
 AFTER TESTING:100 MILLIOHMS Max.  
 4:INSULATION RESISTANCE: 100 MEGAOHMS Min.  
 5:DIELECTRIC WITHSTANDING VOLTAGE: 500 VAC Min.  
 MECHANICAL:  
 1:INSERTION FORCE: 3N-30N.  
 2:WITHDRAWAL FORCE: 3N-30N.  
 3:DURRABILITY: 100 CYCLES.  
 ENVIRONMENTAL:  
 TEMPERATURE RANGE: -20°C TO 60°C.

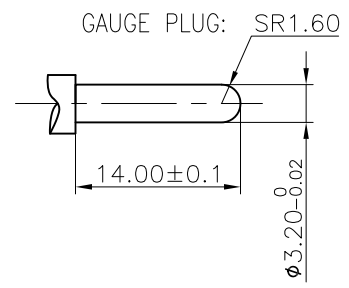
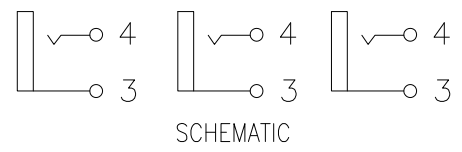
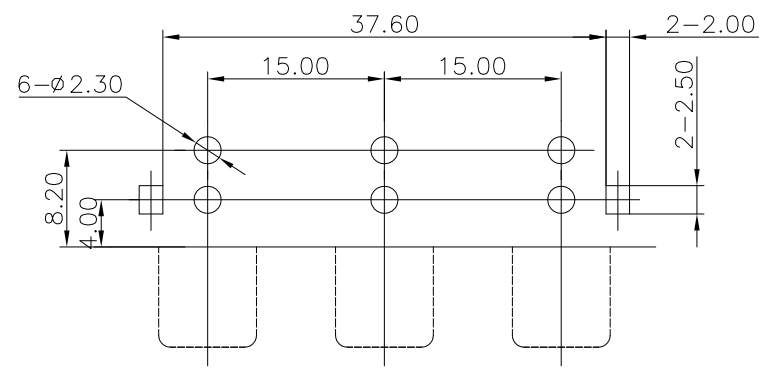

PCB LAYOUT  
TOP VIEW

ANGLE	±5°	MODEL NAME: RCA-325A (PART NO.)	 广东正宝科技有限公司 GUANGDONG TRENPRO TECHNOLOGY CO. LTD.		
63 < L	±0.5				
16 < L ≤ 63	±0.4				
4 < L ≤ 16	±0.3				
L ≤ 4	±0.2	MAT'L: See table	DESIGN: Z.F.Lian 09/07'18	TITLE: RCA PIN JACK	
TOL TABLE:		FINISH: See table	CHECKED: L.W.Wu 09/07'18	DWG NO.:	REV.: A
THIS DOCUMENT IS THE PROPERTY OF ZHENGWEI ELECTRONICS CO.,LTD.,NO PART THEREOF MAY BE REPRODUCED AND USED WITHOUT THE PRIOR WRITTEN CONSENT OF THE OWNER		Q'TY: /	APPROVED: X.Q.Hu 09/07'18	UNIT: mm	VIEW: 
				SCALE: 5:1	SHEET: 1/1
					SIZE: A3